



FIREPLACE **INSERTS**

The fire of your life.

FIREPLACE INSERTS

Fireclay eboris 1300 ultra ivory

Fireclay eboris 1300 ultra black

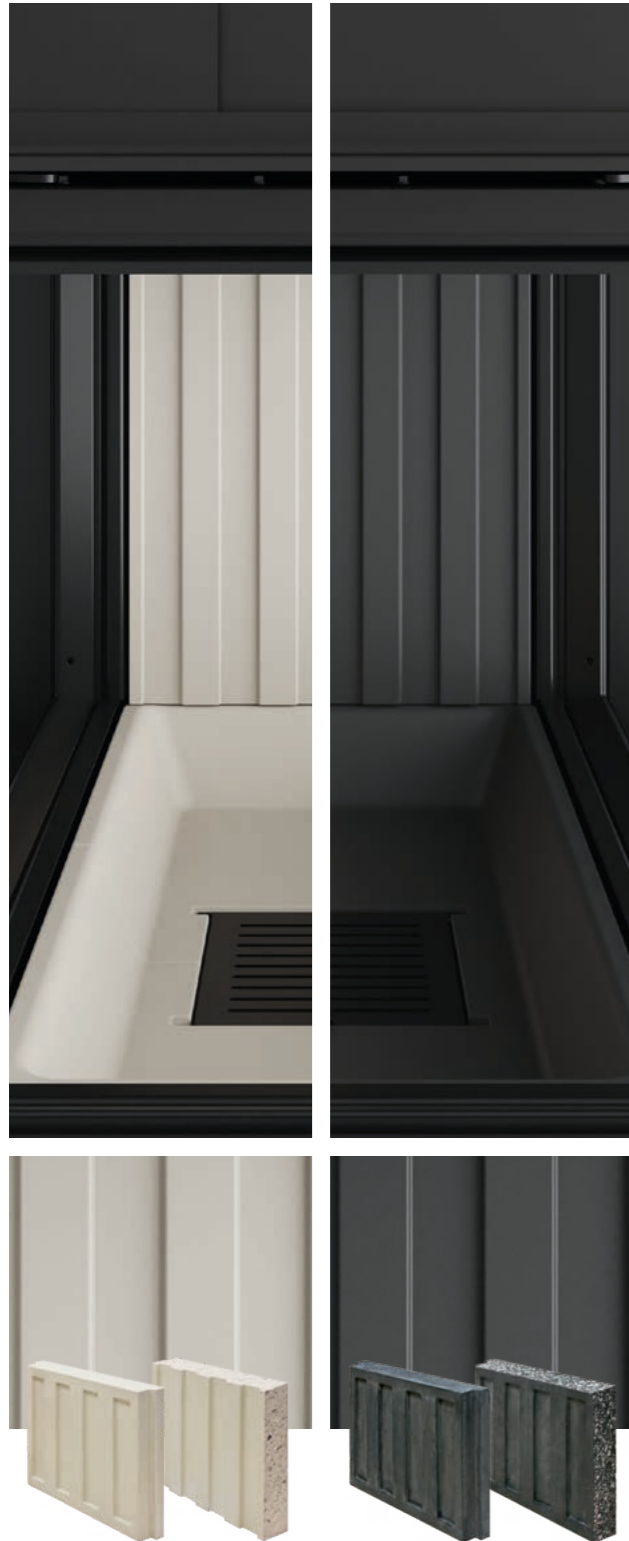



PRODUCT-SPECIFIC PICTOGRAPHS

-  RLA, room air dependent

-  RLU, room air sealed

-  Firewood

-  Lignite

-  S-Thermatik NEO (combustion control)

-  S-USI II (underpressure control)

-  S-ESAM 3.0 (automatic sliding door)

-  S-Kamatik 2 (chimney draft control)

-  S-Vent (convection air assistants)

-  Energy efficiency class

-  Thermal output range (kW)

-  H₂O; water-heat exchanger

- NSHF** Heat recovery surface

-  Straight

-  L-shaped

-  Double Sided

-  U-shaped

INDEX

Page

Premium Edition

Product overview	12
Products	14

Lean

Product overview	30
Products	32

Fireplace Inserts

Product overview	38
Products	40

Classic

Product overview	86
Products	88

NOTE:

Colours may differ slightly from actual colours, due to the printing process. Technical data and colours subject to change. Errors and omissions excepted.

LIVING STYLES –
**INDIVIDUALITY
WITHIN YOUR
OWN FOUR WALLS**

Whether classically elegant or minimalist and reduced: Fireplaces that focus on timeless design in high quality are in vogue. No wonder: If you limit yourself to the essentials in your own four walls and focus on a few, but selected objects, order and peace will return. This provides relaxation and helps make things slow down. Stylish design classics suit this living trend well; they are durable and thus sustainable by nature. Like the fireplace inserts from the exclusive Premium Edition from Spartherm.

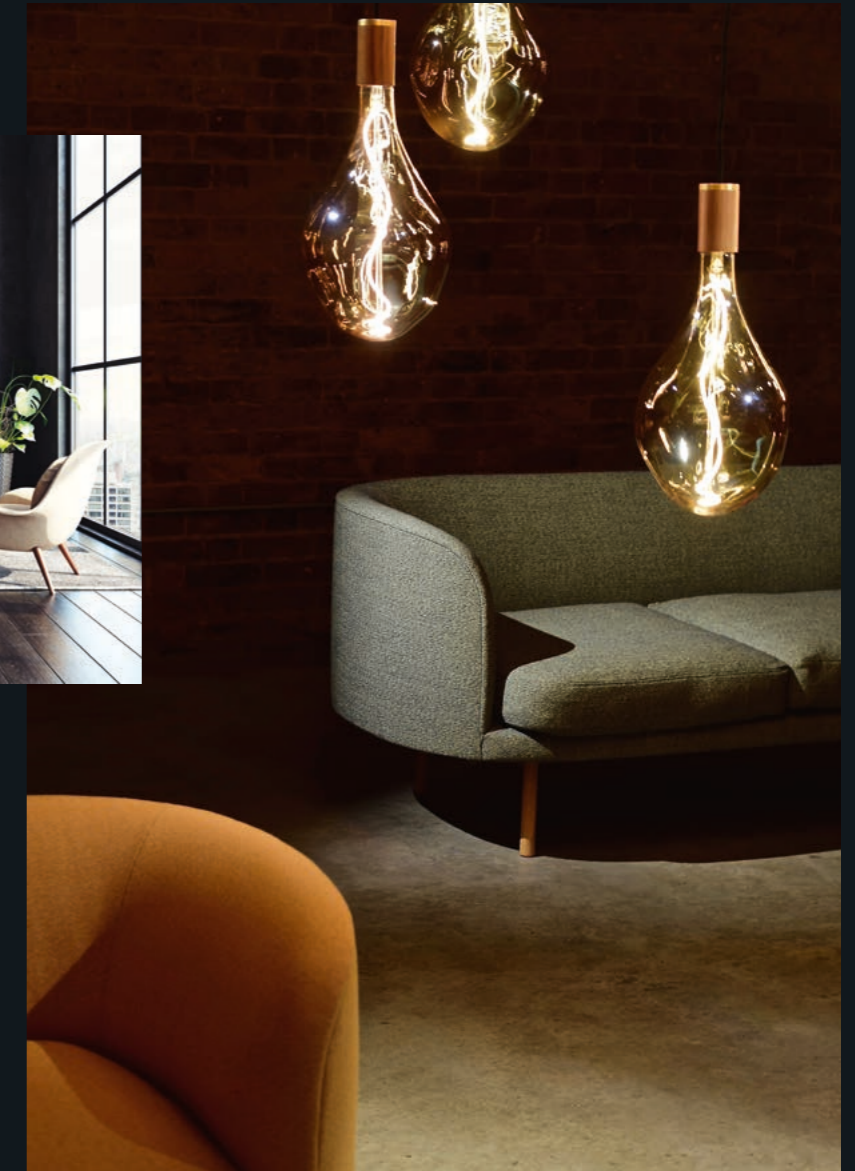

LIVING STYLES



The new furniture is here, but is it still missing that certain something? Without a dash of warmth and naturalness, many interiors seem cool and impersonal. It's the little things that create atmosphere in the interior and set special accents: High-quality materials such as wood or leather. Exquisite fabrics, cushions and plaids. Pictures and books. Lovely colours that create a sense of well-being. But nothing gives the interior such exclusivity and cosiness as a fireplace. When it comes to designing a sophisticated fireplace, the fireplace inserts from the Premium Edition by Spartherm offer an almost inexhaustible variety of creative possibilities. So that the individual fireplace of your dreams, matching your home design, becomes reality.

FUNCTION AND DESIGN IN PERFECTION

Excellent combustion technology for exceptional fireplace architecture

Anyone who sets the highest standards when it comes to interior design does not want to make any compromises when it comes to building a fireplace system. The Premium Edition from Spartherm was created to realise sophisticated projects. Since the company was founded in 1986, Spartherm has been constantly driving innovation at all levels of combustion technology. The Premium Edition bundles this long-standing expertise. When it comes to quality, technology and design, it combines the highest quality fireplace inserts from the Spartherm range. The programme also offers smart fireplace assistance functions and a wide range of customisation options. Central to this is the range of glasses: In addition to fireplace "inserts" or "models" with straight glasses in the contemporary widescreen format, there is also a choice of double-sided devices and L- or U-shaped models. In this way, individual wishes and expansive architectural concepts can be realised. All Premium Edition models have one thing in common: They create unique fireplace experiences!

WHY A
**SPARTHERM
PREMIUM
FIREPLACE
INSERT?**

BENEFITS



Premium V-2R-80h



**COMBUSTION
TECHNOLOGY
AT THE HIGHEST
QUALITY LEVEL**



**SOPHISTICATED
DESIGN**



**CUSTOMISED
DESIGN**

FUNCTION
AND DESIGN
IN PERFECTION

What distinguishes the Premium models?

There is no room for compromises if you want to meet even the most discerning demands. Driven by the desire for perfection, Spartherm has been developing and manufacturing individual fireplace inserts for exceptional fireplace design for over 35 years.

What makes the Premium models from Spartherm so special?

That's simple! They have been developed with a great deal of passion, crafted with craftsmanship and perfected down to the smallest detail.



Refined detail solutions

BENEFITS

- » Clear view of the fire – without a distracting frame
- » Clear, minimalist look
- » No annoying handle in view
- » View of the fire without reflections
- » Low soiling and easy cleaning of the glass
- » Smooth-running sliding mechanism for easier refuelling
- » Clean burning and visually imposing fire bed
- » Space-saving installation of the fireplace system



PREMIUM EDITION

Straight

Variants:

Premium V-1V-87h

Premium V-1V-87h NSHF

from page 14

L-shaped

Variants:

Premium V-2L-55h

Premium V-2L-55h NSHF

Premium V-2R-55h

Premium V-2R-55h NSHF

Premium V-2L-68h

Premium V-2L-68h NSHF

Premium V-2R-68h

Premium V-2R-68h NSHF

Premium V-2L-80h

Premium V-2R-80h

from page 16

Double sided

Variants:

Premium V-FD-87h

Premium V-FD-87h NSHF

from page 22

U-shaped

Variants:

Premium A-U-50h

Premium A-U-70h

Premium A-3RL-60h

Premium A-3RL-80h

from page 24

A WORLD APART. STUNNING DESIGN MEETS SMART TECHNOLOGY.

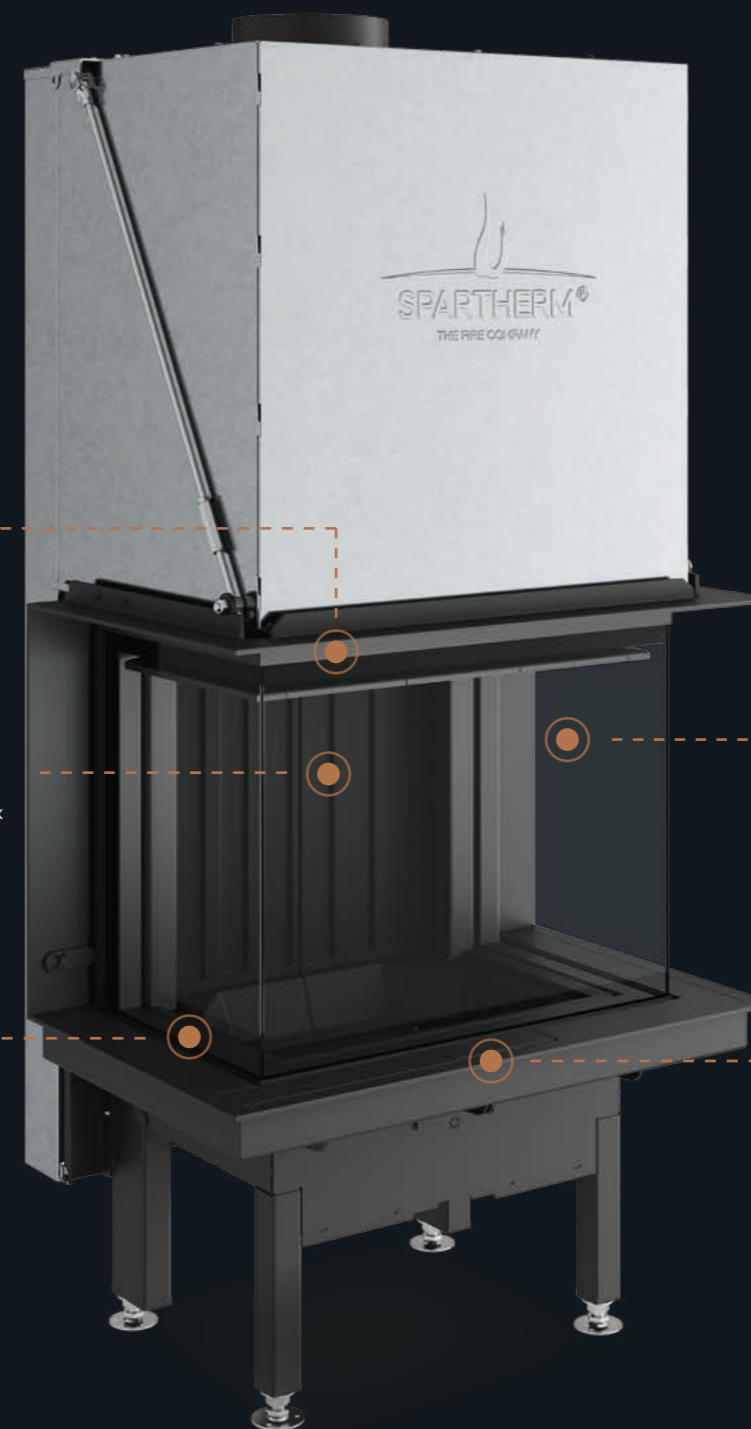

Sturdy, all-round 6 mm steel frame

Strong materials for a sturdy appearance and a minimalist design

Firebox lining

Durable eboris 1300 ultra firebox lining for optimum combustion and high resilience

Combustion compartment door

Recessed door profile, unobstructed view of the fire without visible frame

Polished glass ceramics

High transparency and low reflection, less dirt and easier to clean

Door handle

Flush with the surface and invisible



PREMIUM

Wide-format fireplace

A straight-lined, clean design for perfect integration into spacious architecture. The large-format, polished ceramic glass ensures an unobstructed view of the fire. The Premium V-1V-87h model is a top-class fireplace insert for room concepts in which the fire can unfold its full presence.

SMART FIREPLACE ASSISTANCE FUNCTIONS



S-Thermatik NEO



S-USI II



S-ESAM 3.0



S-Kamatik 2



S-Vent



Premium V-1V-87h

VARIANTS

Premium
V-1V-87h



6.7 – 12.4 kW

Premium
V-1V-87h NSHF



7.6 – 14.2 kW





PREMIUM

Fire experience
from two sides



No distracting door frame, no visible functional elements, pure fire. The L-shaped fireplace inserts from the Premium Edition by Spartherm are ideal when it comes to sophisticated corner solutions. This allows you to view and enjoy the pattern of flames from two perspectives.



VARIANTS

Premium
V-2L-55h
V-2R-55h



5.5 – 10.3 kW

Premium
V-2L-55h
V-2R-55h
NSHF



7.6 – 14.2 kW

Premium
V-2L-68h
V-2R-68h



6.7 – 12.5 kW

Premium
V-2L-68h
V-2R-68h
NSHF



6.9 – 12.9 kW

Premium
V-2L-80h
V-2R-80h



7.4 – 13.7 kW



Premium V-2L-55h



PREMIUM

Fire experience
from two sides

No matter the room situation, this exclusive corner solution presents a perfect view of the fire, letting it unfold in the imposing width of a 68 cm front. Every Premium fireplace insert can be equipped with smart fireplace assistance functions as desired.



Premium V-2L-68h



Premium V-2R-68h

SMART FIREPLACE ASSISTANCE FUNCTIONS*



S-Thermatik NEO



S-USI II



S-ESAM 3.0



S-Kamatik 2



S-Vent

*Compatibilities may vary for models.



PREMIUM

Fire experience
from two sides



Premium V-2L-80h

With the Premium model above the corner, a direct view from two perspectives into the beautiful pattern of the flames is always possible. Pure fire: with this premium fireplace insert, which is allowed to unfold in luxurious width with a front of 80 cm, the door mechanism enables the logs to be reloaded conveniently.



Premium V-2R-80h



PREMIUM

A deep and double-sided fireplace



Refined: With the double-sided version, Spartherm has created a fireplace insert that can be recessed into room dividers or partition walls. The fireplace thus becomes the focal point of the living room. An ideal solution when it comes to integrating a fireplace system into an open-plan room concept. The large-format glass of the Premium V-FD-87h fireplace insert offers an unobstructed view of the fire from all sides.

VARIANTS

Premium V-FD-87h



7.4 – 13.8 kW

Premium V-FD-87h NSHF



7.8 – 14.4 kW



SMART FIREPLACE ASSISTANCE FUNCTIONS



S-Thermatik NEO



S-USI II



S-ESAM 3.0

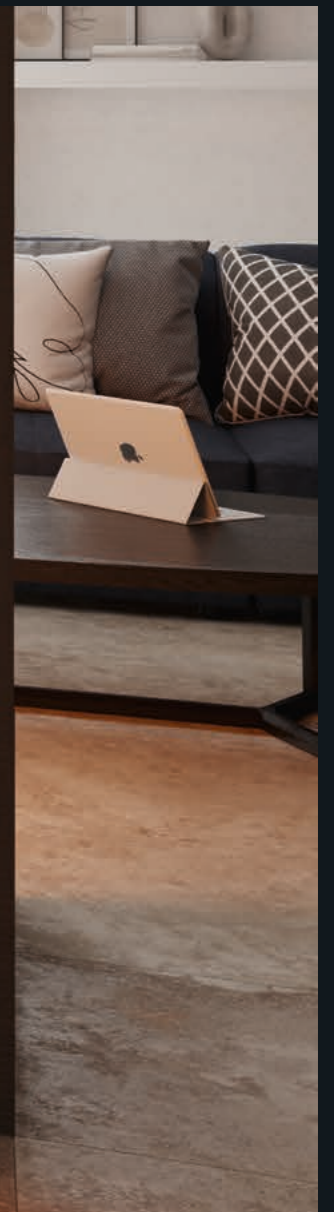

Premium V-FD-87h



PREMIUM

A panoramic view of fire



Premium A-U-50h



Premium A-U-70h

SMART FIREPLACE ASSISTANCE FUNCTIONS



S-Thermatik NEO



S-USI II



S-ESAM 3.0



S-Kamatik 2

The unusual U-shape of the Premium models creates completely new viewing angles and literally lets the fire enter the room. The glasses are almost invisible. This opens the view for the essential: the fascinating pattern of the flames.

VARIANTS

Premium A-U-50h



6.5 – 12.1 kW

Premium A-U-70h



8.0 – 14.8 kW





PREMIUM

A panoramic view of fire



Premium A-3RL-80h

VARIANTS

Premium
A-3RL-60h



7.0 – 13.0 kW

Premium
A-3RL-80h



8.0 – 14.8 kW



More is more: With the U-shaped fire-place inserts of the Premium Edition from Spartherm, the pattern of flames can be viewed not only from one, but from three perspectives. The generous glasses provide an unobstructed view of the pattern of flames. This clearly places the fire at the centre of the interior!

The view from three sides grants the Premium A-3RL-80h a unique depth with embers and flames positioned right in front of the wall and visible from any perspective in the room. The flames immerse their whole surroundings in a warm, fascinating pattern of light. The large 80 cm front allows an unobstructed view of the dancing flames and provides a particularly large amount of soothing radiant heat.



Premium A-3RL-60h

WHY A
**SPARTHERM
LEAN
FIREPLACE
INSERT?**

BENEFITS



Lean 3RL-70h



**GENEROUS-
LOOKING FLAME
FOR SMALL LIVING
SPACES**



**WIDE COMBUSTION
CHAMBER**



**ENERGY-EFFICIENT,
CLEAN AND
ECONOMICAL**

LEAN

MAXIMALES EXPERIENCE IN MINIMUM SPACE.

L-shaped

Variants:

Lean 2L-70h | RLU

Lean 2R-70h | RLU

from page 32

U-shaped

Variants:

Lean 3RL-70h | RLU

from page 34

Low device depth
allows space-saving
installation

Reduced design
compact format

Easier cleaning
tilting large front glass

**Invisible handle
in the frame**
clear view of the fire

**Infrared-coated
combustion chamber glazing**
reduced radiation distance





LEAN

Impressive fire panorama



Lean 2R-70h

The Lean 2L-70h/ Lean 2R-70h fireplace insert will impress you with its consistent design focused on minimising the unit depth. This compact model is ideal wherever space is limited or less heat is required. L-shaped glasses create an impressive fire panorama.

In terms of combustion technology, the innovative Lean model excels thanks to its infrared-coated combustion chamber glazing for a reduced radiation distance and reduced build-up. And there are environmental benefits, too: The compact format ensures efficient and therefore sustainable use of wood as fuel.

VARIANTS

Lean 2L-70h | RLU
Lean 2R-70h | RLU



5.5 – 10.3 kW



Lean 2L-70h



LEAN

Minimum unit depth,
maximum view of the fire

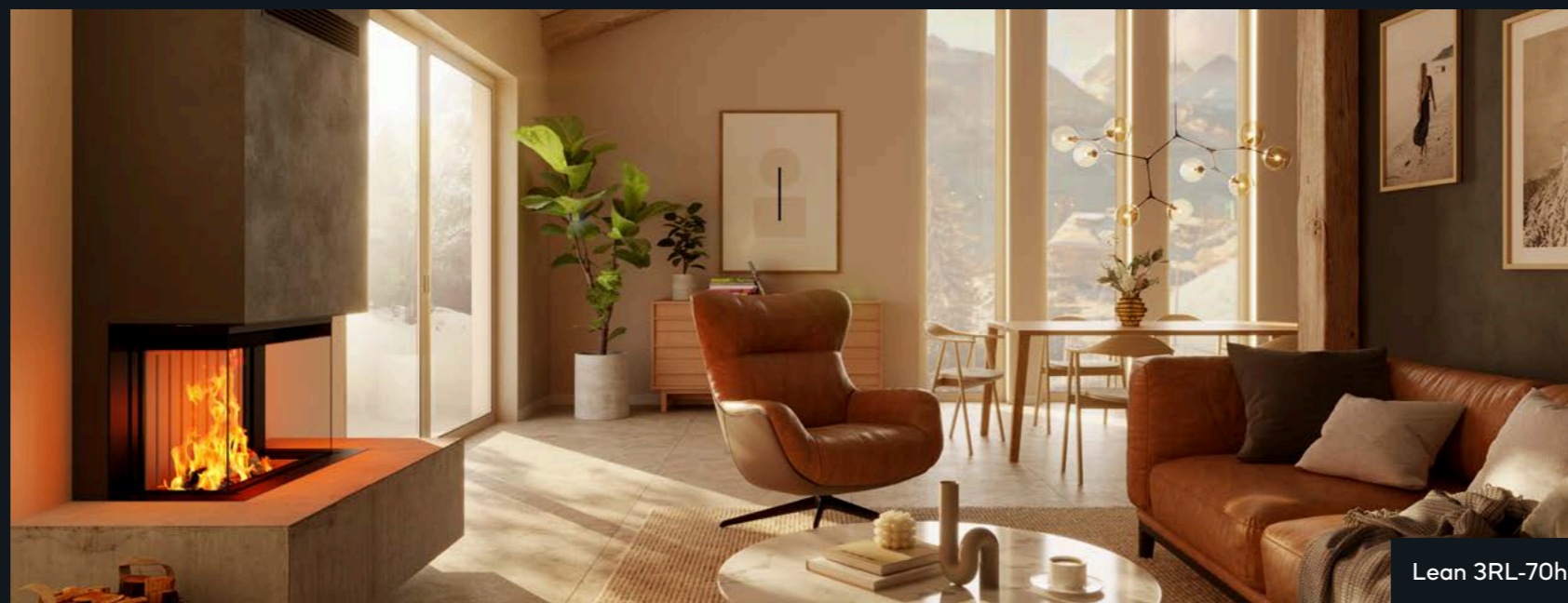

Lean 3RL-70h

The Lean 3RL-70h fireplace insert impresses with its consistently minimised appliance depth. The compact model is ideal when space is limited or the heat requirement is lower. U-shaped viewing panels create an impressive fire panorama. In terms of combustion technology, the innovative Lean model scores highly with infrared-coated combustion chamber glazing for reduced radiation distance and reduced build-up. Plus point for the environment: the compact format ensures efficient and therefore sustainable utilisation of wood as a fuel.



Lean 3RL-70h

SMART FIREPLACE ASSISTANCE FUNCTIONS

- S-Thermatik NEO
- S-USI II
- S-ESAM 3.0
- S-Vent

VARIANTS

Lean 3RL-70h | RLU 5.3 – 9.8 kW



WHAT IS SO
FASCINATING
ABOUT A
**SPARTHERM
FIREPLACE
INSERT?**



Varia FD



**UNIQUE DESIGN,
JUST AS YOU
WANT IT**



**INNOVATIVE
PRODUCTS FOR
EVERY STYLE OF
LIVING**



**AN INDIVIDUAL FIRE-
PLACE EXPERIENCE,
FOR A LIFETIME**

FIREPLACE INSERTS

ARTE

Straight

Arte Bh

from page 40

L-shaped

Arte 2LRh-66

Arte 2LRh-66 NSHF

from page 42

U-shaped

Arte 3RL-60h

Arte U-50h

Arte 3RL-80h

Arte U-70h

Arte 3RL-100h

Arte U-90h

from page 44

MINI

Straight

Mini R1V | RLU

Mini R1V NSHF

Mini Z1 | RLU

Mini Z1 NSHF

Mini S | RLU

Mini Sh | RLU

from page 48

L-shaped

Mini 2L

Mini 2R

Mini 2LRh

from page 52

Double sided

Mini S-FDh

from page 54

VARIA

Straight

Varia 1V | RLU

Varia 1Vh | RLU

Varia 1V NSHF

Varia 1Vh NSHF

Varia 1V-87h

Varia 1V-87h NSHF

Varia Sh | RLU

Varia 1V-100h

Varia ASH | RLU

Varia AS | RLU

Varia ASH NSHF

Varia AS NSHF

Varia Bh | RLU

Varia Ah

Varia M-80h RLU

Varia B-120h

from page 56

L-shaped

Varia 2L-55

Varia 2R-55

Varia 2L-55h | RLU

Varia 2R-55h | RLU

Varia 2L-62

Varia 2R-62

Varia 2L-62 NSHF

Varia 2R-62 NSHF

Varia 2L-62h | RLU

Varia 2R-62h | RLU

Varia 2L-62h NSHF

Varia 2R-62h NSHF

Varia 2L-68h

Varia 2R-68h

Varia 2L-68h NSHF

Varia 2R-68h NSHF

Varia 2Lh

Varia 2Rh

Varia 2Lh NSHF

Varia 2Rh NSHF

Varia AS-2Lh

Varia AS-2Rh

Varia 2L-80h

Varia 2R-80h

Varia 2L-100h

Varia 2R-100h

from page 62

Double sided

Varia FD | RLU

Varia A-FDh

Varia FD-87h

Varia AS-FDh

Varia FD-87h NSHF

Varia AS-FDh NSHF

Varia FDh

Varia B-FDh

from page 68

U-shaped

Varia AS-3RLh

from page 74

VARIA H₂O

Straight

Varia 1V H₂O

Varia 1Vh H₂O

Varia 1V H₂O XL

Varia 1Vh H₂O XL

Varia 1V H₂O XXL

Varia 1Vh H₂O XXL

Varia Ah H₂O

from page 78

L-shaped

Varia 2L-55h H₂O

Varia 2R-55h H₂O

Varia 2Lh H₂O

Varia 2Rh H₂O

from page 80

Double sided

Varia FD H₂O

Varia FDh H₂O

Varia A-FDh H₂O

from page 82

UNIQUE AND CONVINCING.

Variety shape of glass

Highly heat-resistant glass ceramic

Firebox lining

Durable eboris 1300 ultra firebox lining for optimum combustion and high resilience

Door equipment

Maximum sealing behaviour thanks to proven readjustable locking mechanism

Polished glass ceramics

High transparency and low reflection, less dirt and easier to clean

The air control lever

Regulation of the combustion air





ARTE

The balanced
high-format design

This pattern of flame is sure to fascinate. The Arte fireplace insert adds an extraordinary eye-catcher to a cosy ambiance. The impressive high-format design gives the flames plenty of space and slightly emphasises the vertical direction. This creates the perfect stage for amighty fire in all its glory – blazing and yet tamed.

SMART FIREPLACE ASSISTANCE FUNCTIONS*



S-Thermatik NEO



S-USI II



S-ESAM 3.0



S-Kamatik 2



S-Vent

*Compatibilities may vary for models.



Arte Bh

VARIANT

Arte Bh



7.7 – 14.3 kW





ARTE

A special format



Arte 2LRh-66

The flickering flames are presented with understated elegance in this variant of Spartherm's Arte model. The two identical fronts form a slim silhouette for the generous combustion chamber. This allows the flames to develop to imposing size and show their full power. The Arte 2LRh-66 makes the fire visible from two sides and in its full height.

In the Arte fireplace insert, Spartherm combines innovative technology and unique design to create unforgettable fire enjoyment.

VARIANTS

Arte 2LRh-66



4.5 – 8.3 kW

Arte 2LRh-66 NSHF



7.3 – 13.5 kW





ARTE

An elegant division

The wood crackles quietly and the fire's warmth creates a feel-good atmosphere in the spacious room. The U-shaped Arte model from Spartherm is perfect as an elegant divider for spacious rooms while simultaneously creating a special connection through fascinating fire. For this purpose, three different models of the Arte U-series with widths of up to 90 cm are available. These extremely large formats can also be opened with the S-ESAM electric door opener for maximum convenience.



Arte U-90h



Arte U-50h

Visibility from three sides lends a unique expressiveness to this extraordinary fireplace insert, making it an ideal room divider. After all, the flames are in front of the wall and are visible from any point in the room. They immerse their entire surroundings in a warm, fascinating pattern of light – for a fully three-dimensional fire experience. Depending on the model, the Arte can also be supplemented with smart fireplace assistance functions for a relaxed fire experience. When equipped with the underpressure control and the mechanical chimney draft control, the Arte offers even more safety. The electric, automatically operating sliding door called S-ESAM assists with convenient operation and turns time spent by the fireplace into pure relaxation.



Arte U-70h

VARIANTS

Arte 3RL-60h		
		7.0 – 13.0 kW
Arte 3RL-80h		
		8.0 – 14.8 kW
Arte 3RL-100h		
		7.7 – 14.3 kW
Arte U-50h		
		6.5 – 12.1 kW
Arte U-70h		
		8.0 – 14.8 kW
Arte U-90h		
		9.1 – 16.9 kW





ARTE

The special highlight

Three sides, three views, three models. The three sizes of the U-shaped Arte are the perfect stage for impressive flames. Your future dream fireplace can be placed anywhere in the room – whether on the wall or as an elegant room divider. In a variety of formats with a width from 60 cm to 100 cm, it makes the fascination of fire visible from all sides – for a warm and truly captivating pattern of light in a unique format.



Arte 3RL-100h



Arte 3RL-60h



Arte 3RL-80h



MINI

Small fireplace –
great effect



Mini Z1

If you want to set visual highlights in unusual places, you will find a flame for all occasions in the Mini fireplace insert. With its compact dimensions and sophisticated technology, the Mini offers exceptional fire enjoyment. This fireplace insert with its self-closing hinged door not only ensures maximum safety, but is also ideal for installation at a low height, such as under a staircase. Thus, the Mini represents a successful symbiosis of function and design – small but mighty!

VARIANTS

Mini R1V | RLU



4.5 – 6.8 kW

Mini R1V NSHF



4.5 – 8.1 kW

Mini Z1 | RLU



4.9 – 9.1 kW

Mini Z1 NSHF



7.0 – 13.0 kW

Mini S | RLU



4.9 – 9.1 kW

Mini Sh | RLU



4.9 – 9.1 kW





MINI

Small fireplace –
great effect

The fire crackles gently and invites you to linger. With a Mini, you can create a lively highlight even in the smallest room. After all, a genuine fire in a fireplace is an upgrade for any ambiance. So this fireplace insert, which is not too big and yet combines function and design, will fit perfectly even in a corner or on a narrow wall, and is sure to give you an unforgettable fire experience.

In addition, the smart fireplace assistance functions ensure a relaxed fire experience. The electric S-Thermatik NEO, for example, ensures efficient burning of the wood and the S-USI II underpressure control offers even more safety. With the electric, automatically operating sliding door called S-ESAM, operating the Mini becomes extremely convenient, leaving more time for enjoying the fire.



Mini S

SMART FIREPLACE ASSISTANCE FUNCTIONS*



S-Thermatik NEO



S-USI II



S-Vent

*Compatibilities may vary for models.



Mini Sh



MINI

Just change
your perspective

This is the fireplace insert for new insights. If you want to enjoy your fire again and again and in a different way each time, the L-shape of the Mini is the ideal entry-level format for corner fireplaces. The practical Mini 2L or Mini 2R with a self-closing hinged door, for example, is especially suitable for low installation situations. On the convenient Mini 2LRh with an elevating door, the front can even be opened with the S-ESAM electric door opener if desired. The holistic design of the L-shape creates a feel-good ambiance that is visible from two sides.



Mini 2L

VARIANTS

Mini 2L Mini 2R			
		4.9 – 9.1 kW	
Mini 2LRh			
		4.9 – 9.1 kW	



Mini 2LRh



Mini 2R



MINI

For a compact connection



Mini S-FDh

Open, yet separate. If you are looking for the perfect solution for a unique room design, you will find the answer in the "double sided" Mini. This compact Spartherm fireplace lets you see all the way through. To achieve this effect, the fireplace insert with its two glass panes is cleverly integrated into the architecture.

This creates an almost natural connection between two rooms. No matter where you are, the warming fire is with you and remains fascinating from every angle. Enjoy open perspectives even in compact rooms – for a more spacious impression and a special fire experience.

VARIANT

Mini S-FDh

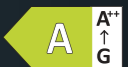

4.5 – 7.8 kW



VARIA

Versatile variants



Varia 1Vh

Blazing, lambent or gently flickering. Fire shows itself in countless facets. Varia fireplace inserts are available in a wide range of variants. But all versions feature the beautifully balanced door format. It's your free choice whether to open the door from the left or the right. A lifting glass is also available and can even be equipped with the S-ESAM electric door opener on request.



Varia Bh



Varia 1V

VARIANTS

Varia 1V | RLU
Varia 1Vh | RLU



7.7 – 14.3 kW

Varia 1V NSHF
Varia 1Vh NSHF



11.9 – 21.2 kW

Varia 1V-87h
Varia 1V-87h NSHF



6.7 – 12.4 kW
7.6 – 14.2 kW NSHF

Varia 1V-100h



7.3 – 13.5 kW

Varia Sh | RLU



7.4 – 13.7 kW

Varia AS | RLU
Varia ASh | RLU



4.9 – 9.1 kW

Varia AS NSHF
Varia ASh NSHF



7.7 – 14.3 kW

Varia Bh | RLU



7.3 – 13.5 kW

Varia B-120h



10.5 – 19.5 kW





VARIA

Fireplace insert in a widescreen format

The Varia-1V family is flexible, even in its performance. Its output ranges from 8.0 kW to 17.0 kW. If you want your life to be more sustainable, you can generate CO₂-neutral hot water for your whole home with the waterconducting H₂O version. Varia fireplaces will inspire you with efficient and innovative technology and with fascinating moments of fire.

Varia Sh is the full-size fireplace for modern architecture. Clearly designed and focussed on the essentials. At 74 x 62 cm, the glass front has a perfectly balanced and generous format. It opens vertically and can also be opened at the touch of a button with our electric sliding door mechanism (S-ESAM).



Varia 1V-87h

SMART FIREPLACE ASSISTANCE FUNCTIONS*



S-Thermatik NEO



S-USI II



S-ESAM 3.0



S-Vent

*Compatibilities may vary for models.



Varia Sh



VARIA

Fire on the big screen

A fire nearly as wide as the horizon. The Varia AS and Varia ASH fireplace inserts feature a sensational wide format that is sure to impress. They have a front width of 75 cm and a height of only 38 cm. These fascinating dimensions emulate a cinema screen.

The fireplace inserts are also compatible with the smart home trend. A smart assistance package featuring the S-Vent ventilation and the digital S-Thermatik NEO combustion control, is available to offer more comfort and safety – for a relaxed fire experience.

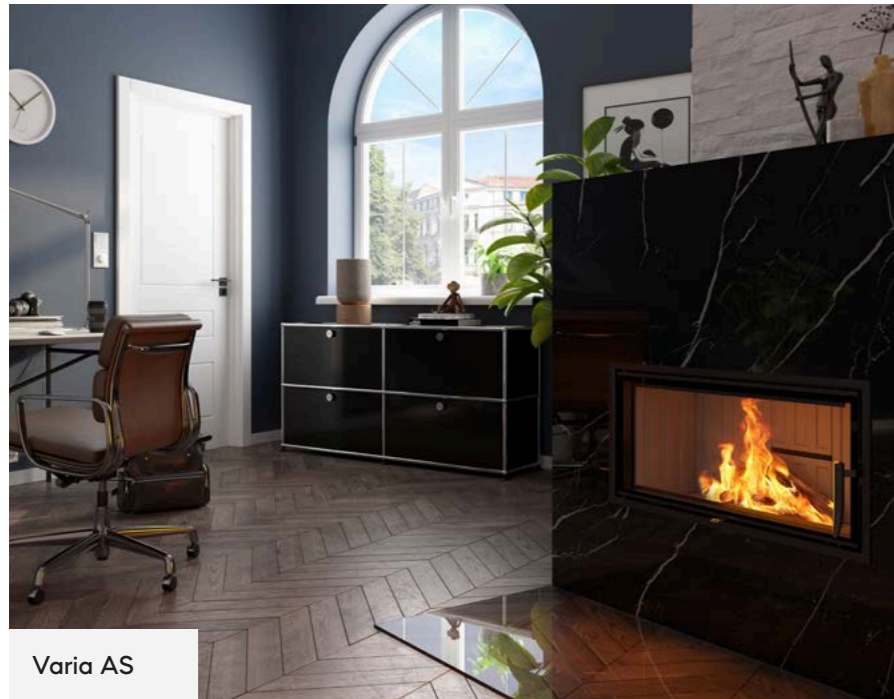

Varia AS

Varia ASH



VARIA

Fire experience from multiple perspectives

Experience the flickering flames from many angles. With its compact corner glass pane, the Varia L-shape offers unobstructed visibility of an impressive fire from two sides. This makes the log-fired fireplace insert a perfect corner solution and opens up options for completely new fireplace positions in the room. Compartments of different sizes for the openly displayed wood store make your time in front of the fireplace insert even cosier.

All Varia corner fireplace models can also provide their power to additional rooms through warm air. The digital S-Thermatik NEO assists in the correct and, above all, safe handling of the fire.















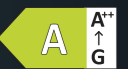





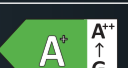

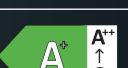



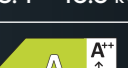

Varia 2L-55h



Varia 2R-62

VARIANTS

Varia 2L-55 Varia 2R-55		
		4.9 – 9.1 kW
Varia 2L-55h RLU Varia 2R-55h RLU		
		4.9 – 9.1 kW
Varia 2L-62 Varia 2R-62		
		4.8 – 9.0 kW
Varia 2L-62h RLU Varia 2R-62h RLU		
Varia 2L-62h NSHF Varia 2R-62h NSHF		4.8 – 9.0 kW 7.0 – 13.0 kW NSHF
Varia 2L-68h Varia 2R-68h		
Varia 2L-68h NSHF Varia 2R-68h NSHF		6.7 – 12.5 kW 6.9 – 12.9 kW NSHF
Varia 2Lh Varia 2Rh		
Varia 2Lh NSHF Varia 2Rh NSHF		7.4 – 13.7 kW 8.4 – 15.6 kW NSHF
Varia AS-2Lh Varia AS-2Rh		
		4.9 – 9.1 kW
Varia 2L-80h Varia 2R-80h		
		7.7 – 14.3 kW
Varia 2L-100h Varia 2R-100h		
		8.6 – 16.0 kW





VARIA

Great design for corners

This fireplace insert is surprisingly different. With the Varia L-shape, Spartherm has created an impressive corner solution in king-size format, the wide front of which provides an unobstructed view of a fascinating pattern of fire.

The orientation of the longer side of the L-shape can be selected freely. This allows the focus to be directed to the fire and makes this fireplace insert a special eye-catcher in a modern ambiance.



Varia 2Lh



Varia 2L-80h



Varia 2L-100h



VARIA

Unique design meets state-of-the-art fireplace technology



Varia 2R-68h



Varia 2L-62h



Varia AS-2Lh



VARIA

Connecting on a grand scale



Varia FDh

Exclusive and impressive. The unique design of the Varia double-sided models creates a fire experience that's in a class of its own. A single fire will fascinate you from two perspectives, while the cosy atmosphere can be felt throughout the entire house. And on top of that, these fireplace inserts all have an energy efficiency class of at least A.



Varia AS-FDh

VARIANTS

Varia FD RLU Varia FDh				8.1 – 15.1 kW
Varia FD-87h Varia FD-87h NSHF				7.4 – 13.8 kW 7.8 – 14.4 kW NSHF
Varia AS-FDh				4.9 – 9.1 kW
Varia AS-FDh NSHF				7.7 – 14.3 kW
Varia B-FDh				7.7 – 14.3 kW





VARIA

Connecting on a grand scale

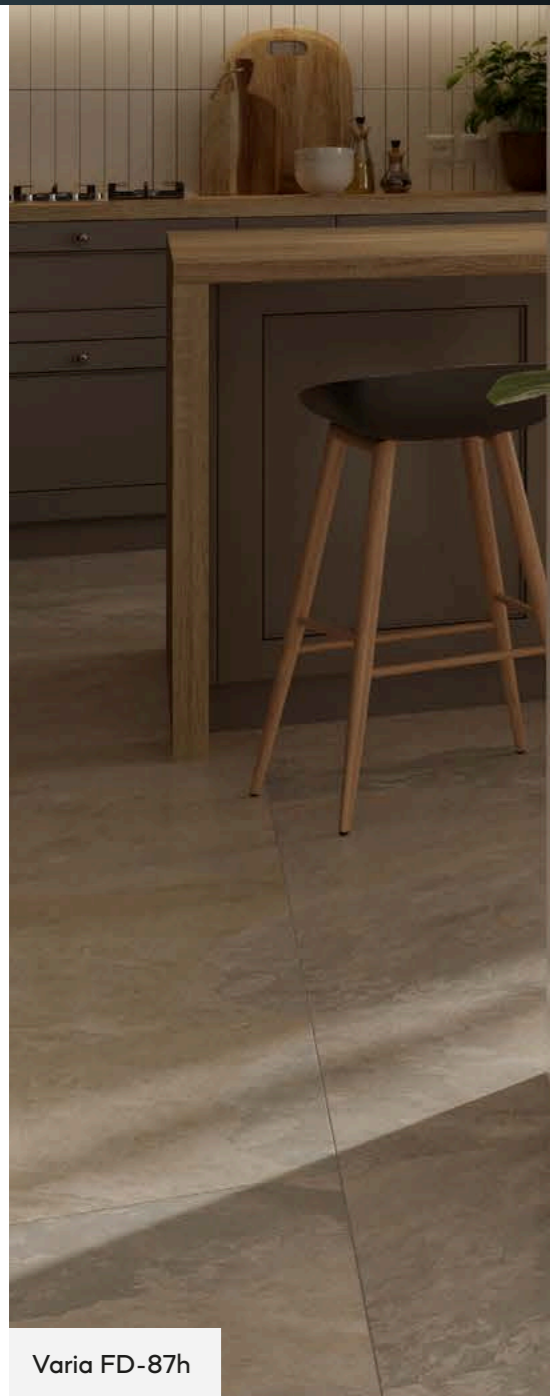

Varia FD-87h



VARIA

The fireplace range
with elegant transparency

Anyone who enters a spacious room with a Varia double-sided fireplace insert will appreciate the cosy, pleasant atmosphere. That is because the different models feature a fascinating and elegant wide format while also presenting the fire as a connecting element between two rooms.



Varia FD



Varia B-FDh



VARIA

It's show time
for flickering flames

This fireplace insert offers a spectacular presentation for a special fire experience. The unique U-shape of the Varia model lets the flames come away from the wall and take the stage in the star role. The warmth and firelight can be experienced from any point in the room thanks to the three sides of the fireplace insert. This spectacle is sure to captivate anyone who sees it.

The optional electric S-ESAM lift for opening the door pane like a theatre curtain further enhances this impression. The warming effect of the Varia models also spreads to other rooms, as the heated air they generate can be felt throughout your home, making it cosy and warm.



Varia AS-3RLh

VARIANT

Varia AS-3RLh



5.9 – 10.9 kW



HOW DOES A HYDRONIC FIREPLACE WORK?

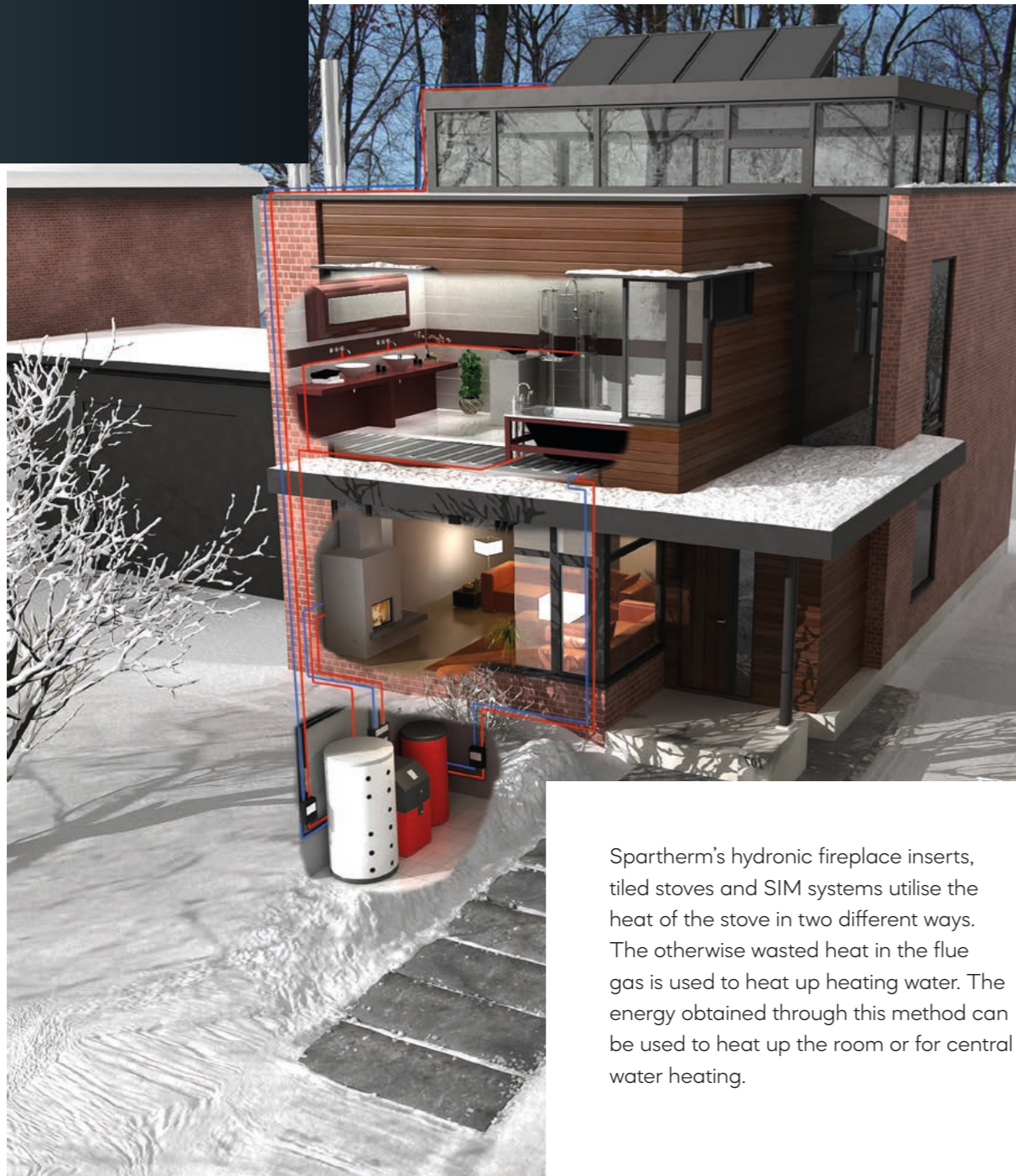

Spartherm's hydronic fireplace inserts, tiled stoves and SIM systems utilise the heat of the stove in two different ways. The otherwise wasted heat in the flue gas is used to heat up heating water. The energy obtained through this method can be used to heat up the room or for central water heating.

The hydronic fireplace insert is integrated in the heating system of the building. A fire in a fireplace generates heat that, depending on the system layout, primarily reaches the living space as radiation or convection heat. Hydronic fireplaces, however, are equipped with a "heat exchanger". It ensures that energy is removed from the unit and can then be used and stored efficiently in other ways.

How does it do that? The heating water is "cold" when it flows through the pipes of the building and into the heat exchanger. It is then heated by the energy of the fire. The heated water flows on into a water tank, the buffer storage. Energy is stored there and can be used in different rooms and at different times, thanks to the heating system, for instance to support the central heating system, or to heat up drinking water.

SPECIAL FEATURES AT A GLANCE

HIGH WATER-SIDE POWER LEVELS

Additional energy transfer via heat exchangers in the double-walled body elements.

A CLEAN SOLUTION

Flue gas heat exchanger with integrated automatic bypass flap for great heating convenience.

QUICK ENERGY TRANSFER

Low water volume = quick heating time and quick usage.

CLEAR VIEW OF THE FIRE

Large glass surface areas, but high water-side power.

HIDDEN TECHNOLOGY

Barely distinguishable from a non-hydronic unit when installed.

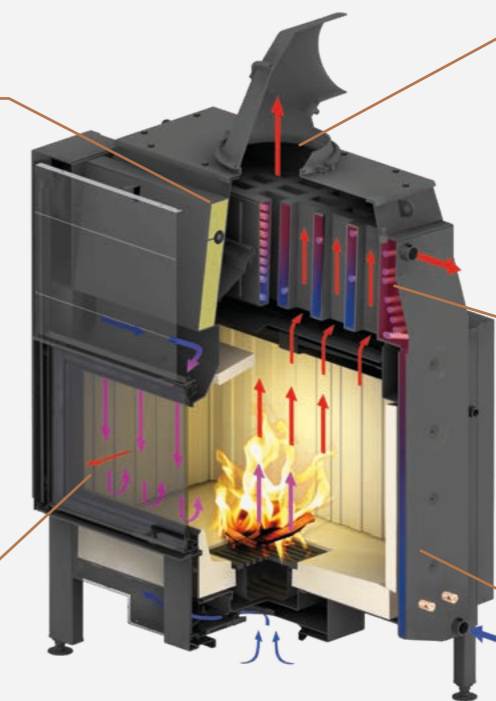



VARIA H₂O

Fire and water



The wood in the Varia H₂O crackles quietly and flares up every now and then. After a while, the cosy warmth will beckon you to sit by the fireplace insert and, once you stare into the flickering flames, you are sure to experience pure relaxation. But these special models of the Varia series won't just make your eyes shine brighter with their unique pattern of fire, they will also impress you with their technical finesse.

These innovative H₂O models produce sustainable and CO₂-neutral hot water through the water heat exchanger in the unit, that can be used in all areas of your entire home. The digital S-Thermostat NEO supports this. All variants of the fireplace insert, fuelled by well-stored logs, achieve energy efficiency class A+ in tests, making them an environment-friendly, sustainable solution.

VARIANTS

Varia 1V H₂O
Varia 1Vh H₂O



5.6 – 10.4 kW

Varia 1V H₂O XL
Varia 1Vh H₂O XL



6.3 – 11.7 kW

Varia 1V H₂O XXL
Varia 1Vh H₂O XXL



10.5 – 19.5 kW



Varia 1V H₂O



VARIA H₂O

Perspectives of flame

Warmth and a feeling of security. These are the sensations that have made a spot by the fire so coveted for all of human history. The sophisticated L-shape of the Varia H₂O with its compact corner panes provides a full view of the flames from two sides. This keeps the flickering flames visible at all times. The ingenious corner solution opens up new dimensions for unique interior design as the fireplace insert can be placed unattached and freely in the room.

All Varia corner fireplace models have yet another advantage. The waterbearing variant is particularly designed for sustainable consumption of resources. Because it produces hot water that is CO₂-neutral - with the fire of innovation. The digital S-Thermatik NEO assists in the correct handling of the fire.



VARIANTS

Varia 2L-55h H₂O
 Varia 2R-55h H₂O



4.9 – 9.1 kW

Varia 2Lh H₂O
 Varia 2Rh H₂O



7.3 – 13.5 kW



Varia 2R-55h H₂O



VARIA H₂O

Greater insights

This design is pure fascination. The double-sided Varia H₂O keeps the flames in view at all times. With its clean lines, the fireplace insert connects two rooms with a unique fire, creating a new architectural experience.

SMART FIREPLACE ASSISTANCE FUNCTIONS



S-Thermatik NEO



S-USI II



Varia FD H₂O

For this purpose, Spartherm has developed different front widths of 67 cm or 87 cm that fit seamlessly into a wall design. The large-format, fully non-reflective ceramic glass panes are sure to fascinate you with an unobstructed view of the lively fire.

But the double-sided models of the Varia H₂O can also be adapted to individual needs. Additional features can create an even greater-quality fire experience. In addition to a classic swing door, an elevating stove door is also available. For even more convenient operation, the latter can also be equipped with the S-ESAM electric door opener, if desired. Just like the other Varia H₂O models, this variant is designed to produce hot water in a sustainable and CO₂-neutral way.

VARIANTS

Varia FD H₂O
Varia FDh H₂O



7.0 – 13.0 kW

Varia A-FDh H₂O



7.3 – 13.5 kW



WHAT IS SO
FASCINATING
ABOUT A
**SPARTHERM
CLASSIC?**



**EFFICIENT AND
ENVIRONMENTALLY
FRIENDLY**



**LOW
MAINTENANCE**



**HIGH DURABILITY
THANKS TO TESTED
QUALITY**



Renova Cs-50

CLASSIC

RENOVA

☐ Straight

Variants:

Renova B-Air

Renova Cs-42

Renova Cs-50

Renova C-44

from page 88

COSINESS WITH STATE-OF-THE-ART TECHNOLOGY.





RENOVA

The compact all-rounder



Renova B-Air

VARIANT

Renova B-Air



6.2 – 11.4 kW



SMART FIREPLACE ASSISTANCE FUNCTIONS



S-Thermatik NEO



S-USI II

With its compact design, the Renova B-Air is the perfect heating insert for replacing or installing a new tiled stove. It fits almost all stove models. Externally, it impresses with a narrow frame that offers maximum visibility of the combustion chamber. Its clear shapes and elegant rectangular viewing window blend in perfectly with the design of historical and modern tiled stoves. Thanks to a sturdy handle, the door to the combustion chamber can be opened easily and conveniently. With state-of-the-art combustion technology, this high-quality all-rounder guarantees both energy-efficient and low-emission heating. This reduces costs and protects the environment.



RENOVA

Modern design, slim format

Lots of function and convenience in a small space:
The Cs-42 and Cs-50 heating inserts are identical in design to the Renova C-44 model, but are significantly narrower. The compact format supports energy-efficient and low-emission heating. The appliances are equipped with a clearly designed front panel in which the doors for the combustion chamber and ash drawer are integrated flush. The spacious ash drawer can be completely covered and removed; it holds five to six litres of ash.



Renova Cs-42

VARIANTS

Renova Cs-42 (Firewood)			4.6 – 8.5 kW
Renova Cs-42 (Lignite)			4.6 – 8.5 kW
Renova Cs-50 (Firewood)			4.9 – 9.1 kW
Renova Cs-50 (Lignite)			4.9 – 9.1 kW



Renova Cs-50

SMART FIREPLACE ASSISTANCE FUNCTION



S-USI II



RENOVA

Ideal for replacement
and new installations

The Renova C-44 is a compact tiled stove insert that is equally suitable for a new installation or as a replacement appliance. The model is characterised by a large glazed viewing panel that provides a perfect view of the flames. In terms of combustion technology, the Renova C-44 guarantees particularly energy-efficient and low-emission heating. The panel creates a perfect transition between the heating element and the surface of the tiled stove. There is an additional door underneath the combustion chamber door, which conceals a spacious ash drawer. This can be covered and easily removed completely for clean disposal of the ash. Both doors are fitted with solid, parallel handles, whose clear design perfectly rounds off the elegant exterior of the heating insert.



Renova C-44

VARIANT

Renova C-44
(Firewood)



6,0 – 11,1 kW

Renova C-44
(Lignite)



5,5 – 10,1 kW



Renova C-44

SMART FIREPLACE ASSISTANCE FUNCTION



S-USI II

SPARTHERM® PRODUCT RANGE



Varia 2R-80h

DESIGN YOUR
PERSONAL
MOMENT OF **FIRE.**

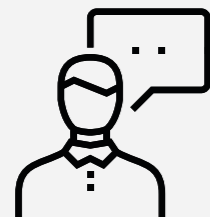

PRODUCT CONSULTANT

WHICH FIRE GOES BEST WITH YOUR FIRE?
Find the fireplace insert that precisely meets your requirements in just a few steps!

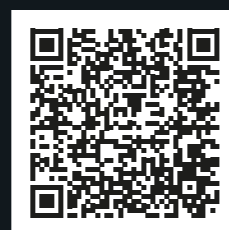

www.spartherm.com



STOVES

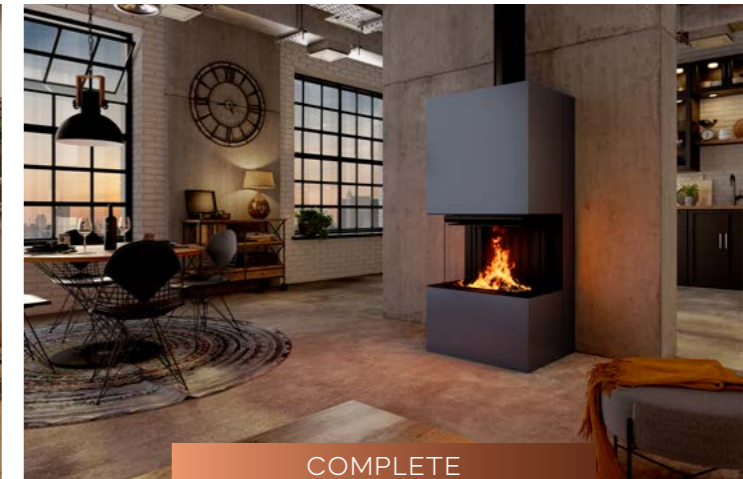

COMPLETE
FIREPLACE SYSTEMS

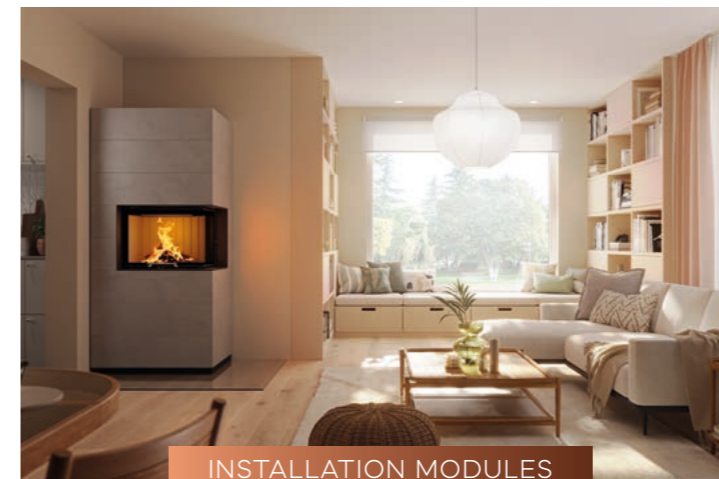

INSTALLATION MODULES
SIM SERIE



FIREPLACE CASSETTES
AND FIREPLACE DOORS



DECO FIRE



SPECIALIST DEALERS

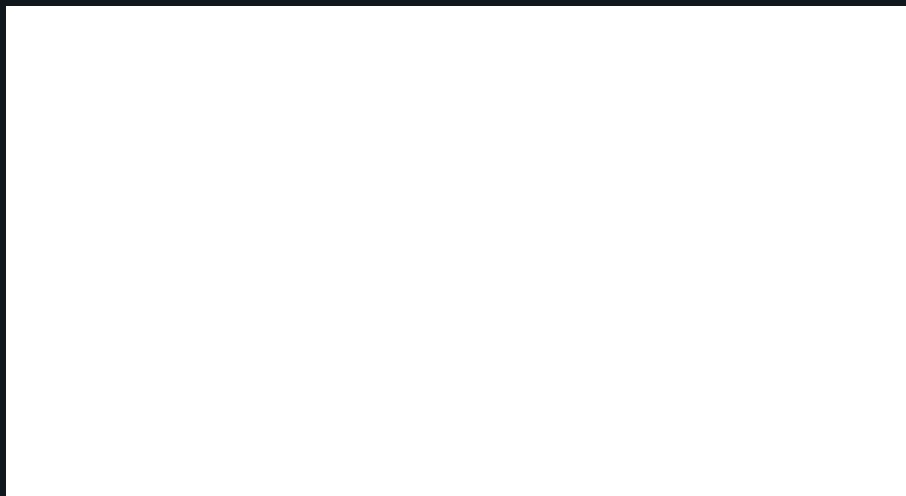

www.facebook.com/spartherm

www.instagram.com/spartherm

www.youtube.com/sparthermgermany

www.spartherm.com

