

BOX 2L 1500

ebios-fire



Indice

Pagina

BOX 2L 1500

02

LINE 1500

03

BOX 2L 1500+

04

LINE+ 1500

05

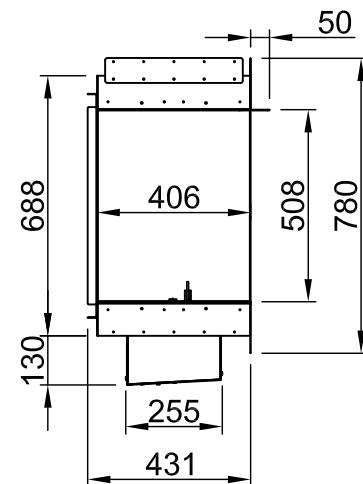
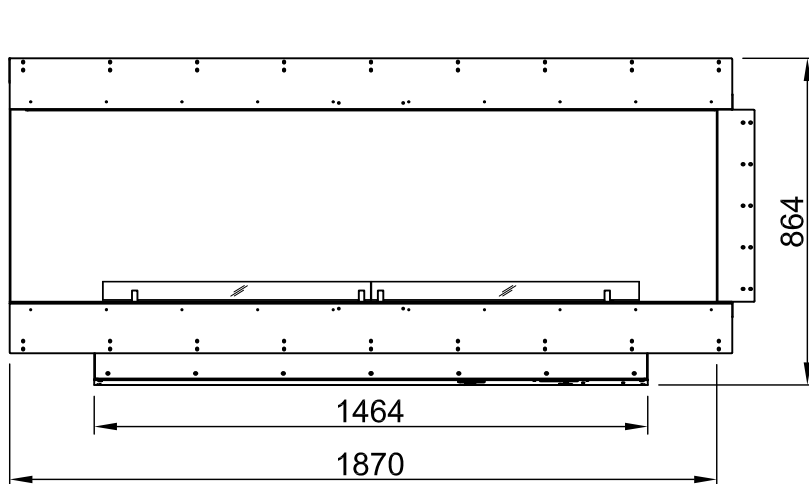
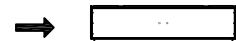
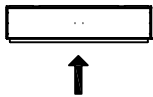

 ~1:20

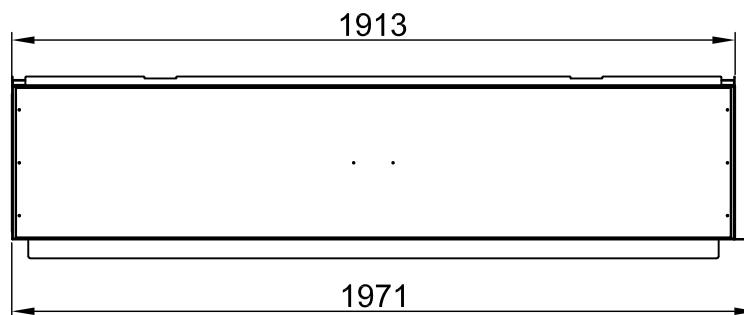
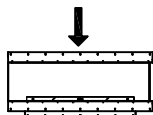

 ~1:20

<p>Alle Abbildungen und Zeichnungen sind urheberrechtlich geschützt. Verwertung oder Veröffentlichung, auch einzelner Details, nur mit unserer Genehmigung. Technische Änderungen und Irrtümer vorbehalten. All representations and drawings are protected by applicable copyright laws. Utilisation or publication, including individual details, only with our written approval. Technical data subject to change. Errors and omissions excepted. Tutte le immagini e tutti i disegni sono protetti da diritto d'autore. L'uso o la pubblicazione, anche di dettagli singoli, necessitano della nostra autorizzazione. Con riserva di modifiche tecniche e errori. Todas las ilustraciones y todos los dibujos están protegidos por derechos de propiedad intelectual. Solo se permite el uso o la publicación. Incluso de detalles particulares, con nuestra autorización. Reservado el derecho a realizar modificaciones técnicas y correcciones de errores. Alle afbeeldingen en tekeningen zijn auteursrechtelijk beschermd. Gebruik of publicatie, ook van aparte gegevens, alleen met onze toelating. Technische wijzigingen en mogelijke fouten voorbehouden. Wszystkie grafiki i rysunki chronione są prawem autorskim. Wykorzystywanie lub publikowanie, również pojedynczych szczegółów, wyłącznie za naszą zgodą. Zastrzegamy sobie prawo do zmian technicznych i pomyłek. Все рисунки и чертежи защищены авторским правом. Использование или публикация, в том числе отдельных фрагментов, только с нашего разрешения. Возможны технические изменения и ошибки.</p>	<p>*optional *optional *optional *optional *optional *optional</p>
---	---

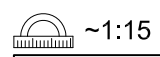
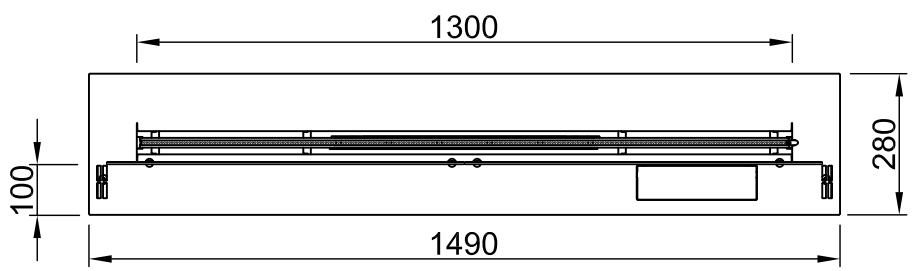
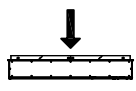
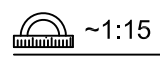
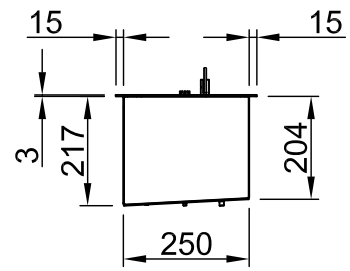
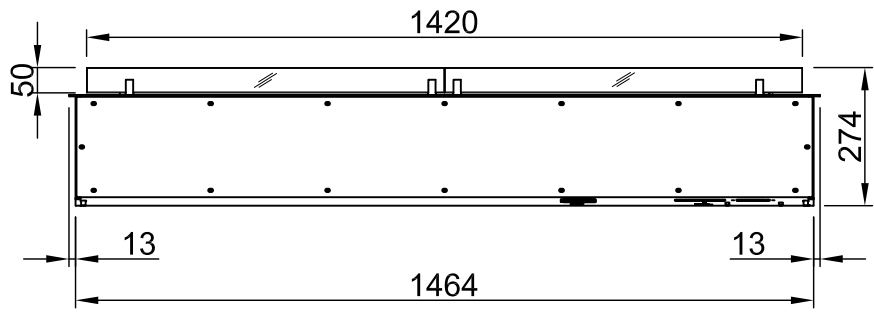
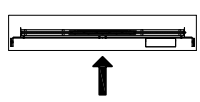

<p>Alle Abbildungen und Zeichnungen sind urheberrechtlich geschützt. Verwertung oder Veröffentlichung, auch einzelner Details, nur mit unserer Genehmigung. Technische Änderungen und Irrtümer vorbehalten. All representations and drawings are protected by applicable copyright laws. Utilisation or publication, including individual details, only with our written approval. Technical data subject to change. Errors and omissions excepted. Tutte le immagini e tutti i disegni sono protetti da diritto d'autore. L'uso o la pubblicazione, anche di dettagli singoli, necessitano della nostra autorizzazione. Con riserva di modifiche tecniche e errori. Todas las ilustraciones y todos los dibujos están protegidos por derechos de propiedad intelectual. Solo se permite el uso o la publicación. Incluso de detalles particulares, con nuestra autorización. Reservado el derecho a realizar modificaciones técnicas y correcciones de errores. Alle afbeeldingen en tekeningen zijn auteursrechtelijk beschermd. Gebruik of publicatie, ook van aparte gegevens, alleen met onze toelating. Technische wijzigingen en mogelijke fouten voorbehouden. Wszystkie grafiki i rysunki chronione są prawem autorskim. Wykorzystywanie lub publikowanie, również pojedynczych szczegółów, wyłącznie za naszą zgodą. Zastrzegamy sobie prawo do zmian technicznych i pomyłek. Все рисунки и чертежи защищены авторским правом. Использование или публикация, в том числе отдельных фрагментов, только с нашего разрешения. Возможны технические изменения и ошибки.</p>	<p>*optional *optional *optional *optional *optional *optional</p>
---	--

BOX 2L 1500+

ebios-fire

2022/03

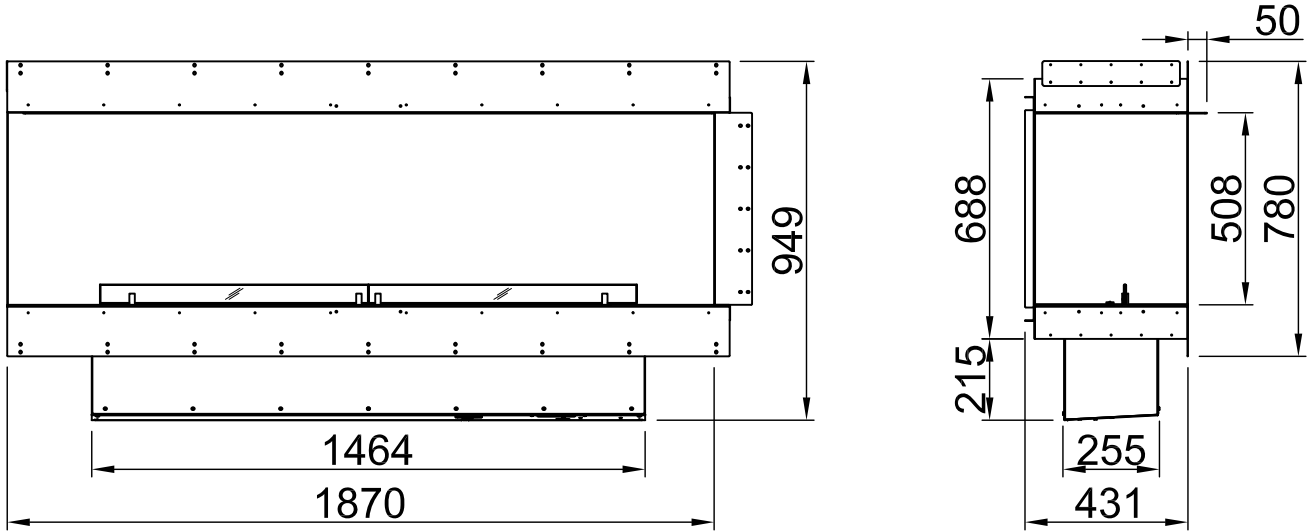
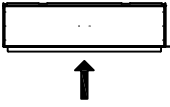

~1:20

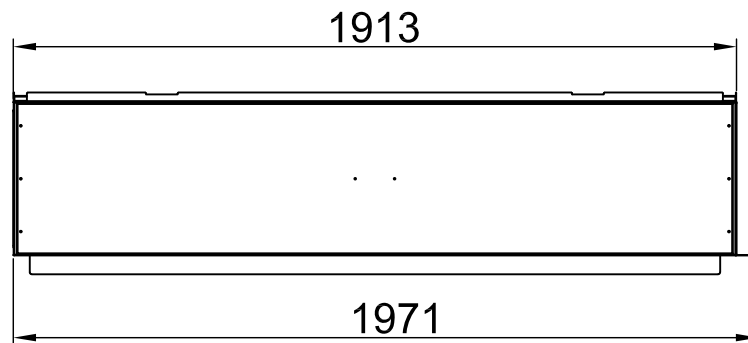
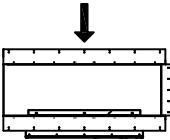

~1:20

<p>Alle Abbildungen und Zeichnungen sind urheberrechtlich geschützt. Verwertung oder Veröffentlichung, auch einzelner Details, nur mit unserer Genehmigung. Technische Änderungen und Irrtümer vorbehalten. All representations and drawings are protected by applicable copyright laws. Utilisation or publication, including individual details, only with our written approval. Technical data subject to change. Errors and omissions excepted. Tutte le immagini e tutti i disegni sono protetti da diritto d'autore. L'uso o la pubblicazione, anche di dettagli singoli, necessitano della nostra autorizzazione. Con riserva di modifiche tecniche e errori. Todas las ilustraciones y todos los dibujos están protegidos por derechos de propiedad intelectual. Solo se permite el uso o la publicación. Incluso de detalles particulares, con nuestra autorización. Reservado el derecho a realizar modificaciones técnicas y correcciones de errores. Alle afbeeldingen en tekeningen zijn auteursrechtelijk beschermd. Gebruik of publicatie, ook van aparte gegevens, alleen met onze toelating. Technische wijzigingen en mogelijke fouten voorbehouden. Wszystkie grafiki i rysunki chronione są prawem autorskim. Wykorzystywanie lub publikowanie, również pojedynczych szczegółów, wyłącznie za naszą zgodą. Zastrzegamy sobie prawo do zmian technicznych i pomyłek. Все рисунки и чертежи защищены авторским правом. Использование или публикация, в том числе отдельных фрагментов, только с нашего разрешения. Возможны технические изменения и ошибки.</p>	<p>*optional *optional *optional *optional *optional *optional *optional</p>
---	--

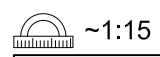
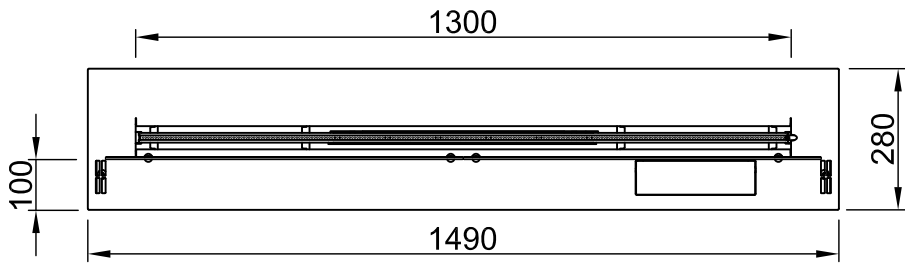
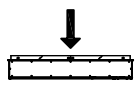
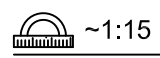
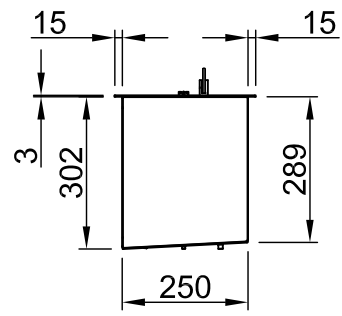
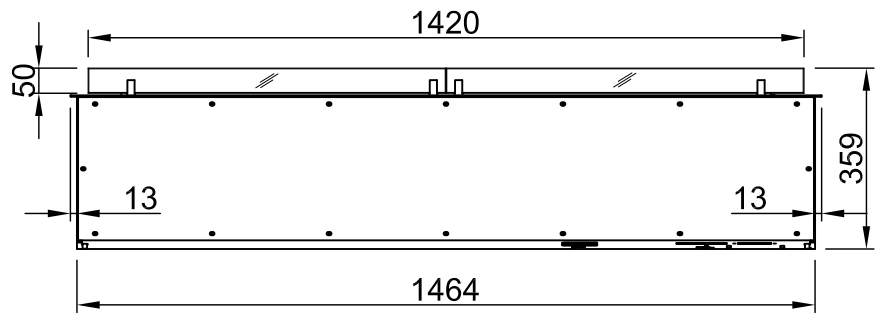
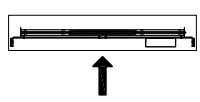

<p>Alle Abbildungen und Zeichnungen sind urheberrechtlich geschützt. Verwertung oder Veröffentlichung, auch einzelner Details, nur mit unserer Genehmigung. Technische Änderungen und Irrtümer vorbehalten. All representations and drawings are protected by applicable copyright laws. Utilisation or publication, including individual details, only with our written approval. Technical data subject to change. Errors and omissions excepted. Tutte le immagini e tutti i disegni sono protetti da diritto d'autore. L'uso o la pubblicazione, anche di dettagli singoli, necessitano della nostra autorizzazione. Con riserva di modifiche tecniche e errori. Todas las ilustraciones y todos los dibujos están protegidos por derechos de propiedad intelectual. Solo se permite el uso o la publicación. Incluso de detalles particulares, con nuestra autorización. Reservado el derecho a realizar modificaciones técnicas y correcciones de errores. Alle afbeeldingen en tekeningen zijn auteursrechtelijk beschermd. Gebruik of publicatie, ook van aparte gegevens, alleen met onze toelating. Technische wijzigingen en mogelijke fouten voorbehouden. Wszystkie grafiki i rysunki chronione są prawem autorskim. Wykorzystywanie lub publikowanie, również pojedynczych szczegółów, wyłącznie za naszą zgodą. Zastrzegamy sobie prawo do zmian technicznych i pomyłek. Все рисунки и чертежи защищены авторским правом. Использование или публикация, в том числе отдельных фрагментов, только с нашего разрешения. Возможны технические изменения и ошибки.</p>	<p>*optional *optional *optional *optional *optional *optional</p>
---	--